



	Job No.
Lifting vehicle with jack	4 0 - 0 1 0
Positioning of jacking up shoes and jacks	013
Survey rims and tires	100
Rims	102
Tires	104
Tire inflation pressure	106
Snow chains	106
Removing and mounting of wheels	110
Removing and mounting hub cap for forged light alloy rims	113

Note

Carefully lift vehicle to avoid accidents and damage to vehicle. Prior to lifting vehicle with a vehicle jack, be sure to protect vehicle by means of chocks (part No. 110 583 01 75) or the like against moving off.

For safety reasons (risk of tilting) T-sedans model 123 and special vehicles (special body) models 114, 115 and 123 should be lifted in empty condition only.

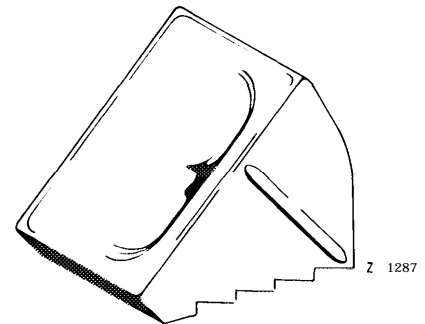

On level ground, protect one wheel of opposite vehicle end against moving off.

On a gradient, protect both wheels of opposite vehicle end against moving off.

On vehicles with manual transmission, engage first gear step. On vehicles with automatic transmission, place selector lever into position "P".

Step down energetically on parking brake pedal.

Push mounting pin of vehicle jack completely into respective plug-in tube (3) in outer longitudinal member of frame.

Position vehicle jack vertically — also on a gradient.

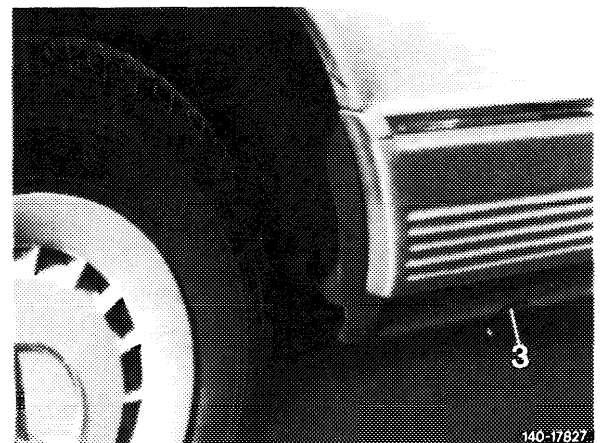

40-013 Positioning of jacking-up shoes and jacks

Special tools

Jacking-up shoe
required 4 each

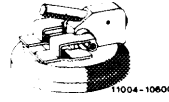

123589 11 6300

C. Model 201

Position jacks directly at mounting points (hard rubber plates) at front and rear similar to lifting with lifting platforms at outer frame side members. However, only jacks with a flat supporting surface are suitable for this purpose.

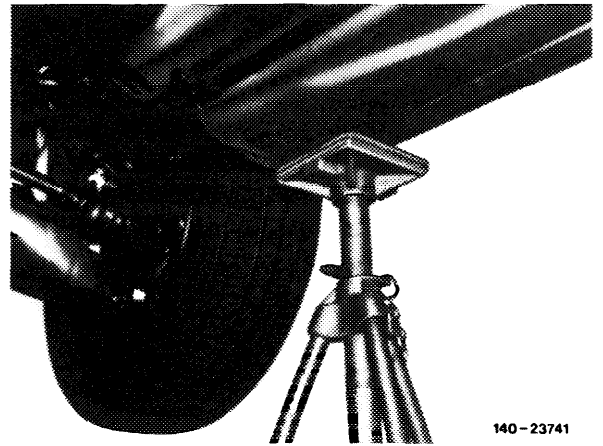

140-23741

40-1 00 Survey rims and tires

Model	Year	Rim	Off set	Summer tires Radial tires (Tubeless) Tires Size	Winter tires Radial tires (Tubeless) Tires Size
201.024	1984- 1985	5J x 14 H2	50 mm	175/70 R 14 82T or 84T	175/70 R 14 82Q or 84Q M + S or 175/70 R 14 82T or 84T M + S
201.122	1984- 1985	5J x 14 H2	50 mm	175/70 R 14 82S or 84S	175/70 R 14 82Q or 84Q M + S or 175/70 R 14 82T or 84T M + S
20 1.024	1986	6J x 15 H2	49 mm	185/65 R 15 87H	185/65 R 15 87T M+S
201.126	1986-	6J x 15 H2	49 mm	185/65 R 15 87T or 87S	185/65 R 15 87T M + S
201.034	1986- 1987	7J x 15 H2	44 mm	205/55 VR 15	205/55 R 15 87T M + S
201.028	1987- 1988	6J x 15 H2	49 mm	185/65 R 15 87H	185/65 R 15 87T M + S
201.029	1987-	6J x 15 H2	49 mm	185/65 VR 15	185/65 R 15 87T M + S
201.128	1987	6J x 15 H2	49 mm	185/65 R 15 87H	185/65 R 15 87T M + S

Note

Each vehicle should be provided with rims of the same version on principle.

Mount only rims approved by us. When in doubt, the MB part no. adjacent to general designation will be decisive.

Designation and part no. are located on wheel disk (on steel plate and light alloy rims outside, on forged light alloy rims inside). As an additional identification a Mercedes star is impressed on steel plate rims starting July 1973, on light alloy rims from start of production.

The additional identification A for symmetrical rim section, B for asymmetric rim section is no longer used on present passenger car rims, since only wheels with asymmetric rims are mounted. Mercedes-Benz wheels have an asymmetric rim and are provided outside and inside with a normal hump.

Rims with a hump at outside only are carrying the designation "H". At high air loss of tire, the hump prevents sliding of tire bead into well-base rim, that is, a sudden venting of tire. For tubeless tires at least one hump on rim outer side is specified.

If, in connection with a change of tire size, vehicles are converted to another rim size, approved by the company, attention must be paid to national laws and regulations prior to conversion.

Rim designations

Example:

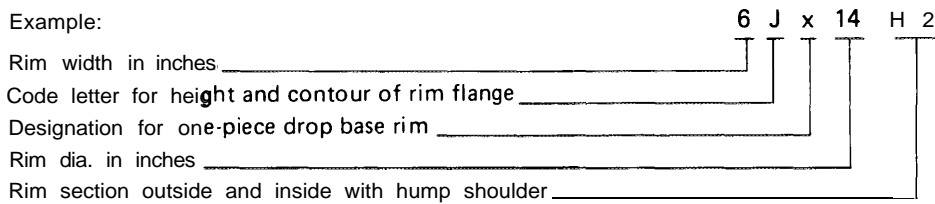

- a Rim width in inches
- d Rim dia. in inches (measuring points dia.)
- e Rim offset – ET
(distance from rim center to contact surface of wheel disk, measured in mm)
- l Hole circle dia. = 112mm
- z Centering bore dia. = 66.5 ± 0.1 mm
- H Hump (rim with safety shoulder)

Steel plate and light alloy rim

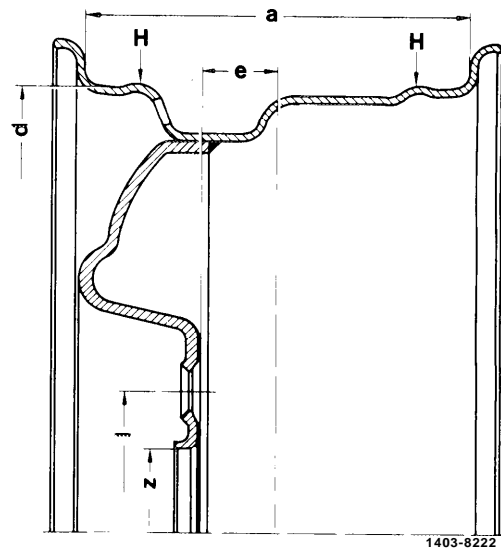

Forged light alloy rim

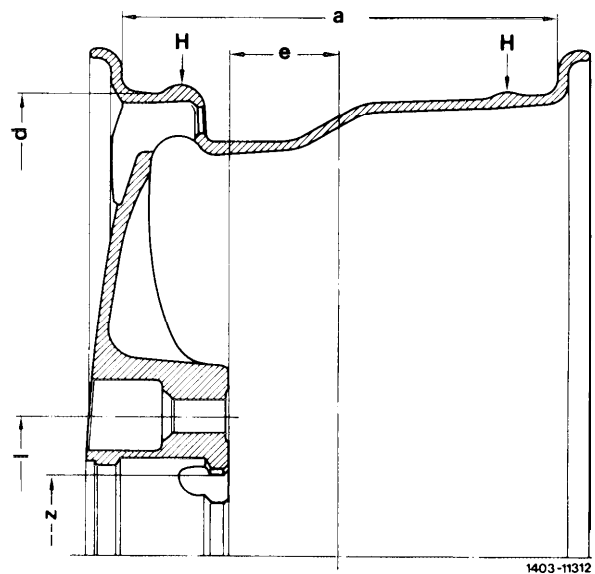

Rim designation

- 1 Rim designation e.g. 6 J x 14 H 2
- 2 Part no. e.g. 108 400 14 02
- 3 Identification as original Mercedes-Benz part.
- 4 Production code number or production date
 - a) Identification of production plate including month/year up to February 1978, e.g. = January 1978
 - b) Identification of production date including week/year starting March 1978, e.g. 13 78 = 13th week 1978

5 Trademark of manufacturer

6 Part number of manufacturer

7 Rim offset – ET

Designation of rim offset:

- a) On steel plate rims for the first time with ET 50 (rim 5 J x 14 H2 only) starting with production code number 41 81.
- b) On forged light alloy rims starting with production code number 32 81.

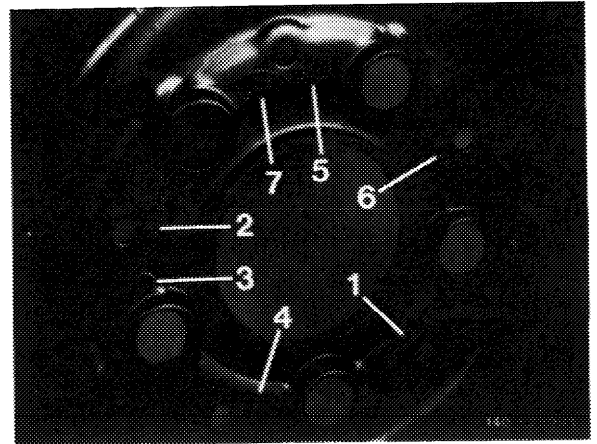

Identification on steel plate and light alloy rims outside

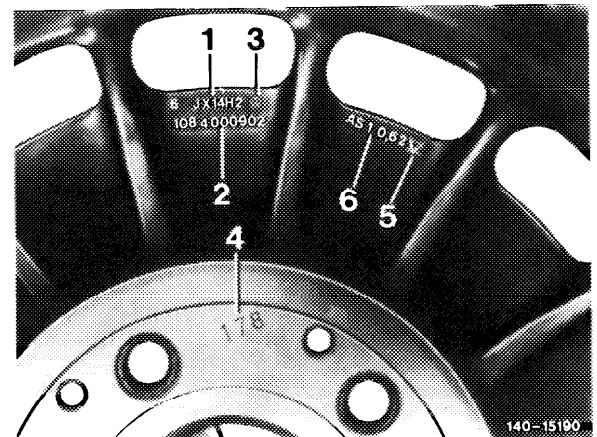

Identification on forged light-alloy rims inside

Version for models 107, 114, 115, 116, 123 and 126

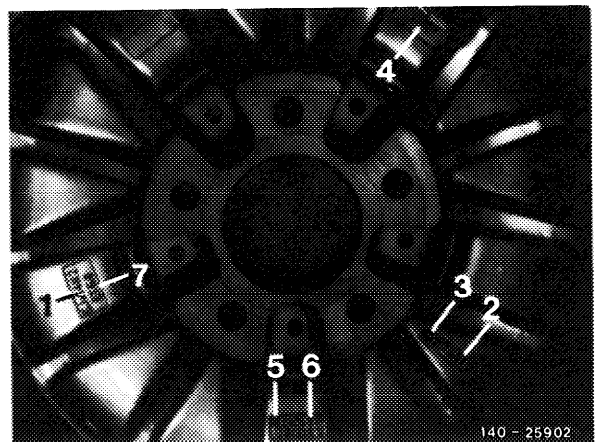

Version for model 201

Steel plate rims

On steel plate rims the seat of the tire bead on radius toward rim flange and on rim flange itself, as well as the outer surfaces, particularly on inside of wheel, should not show any rust marks. Prior to fitting a new rubber valve, clean contact surfaces on rim. If required, derust surfaces and apply fresh paint.

Particularly during the six winter months, check rims inside for contamination and clean, if required.

For steel plate rims the design of the fastening eyes is decisive for accurate fastening of wheels. Wheels with raised fastening eyes provide a very high degree of safety against excessive tightening of spherical collar bolts as compared with recessed fastening eyes used on former types of wheels.

1st version
Wheel with recessed
fastening eyes

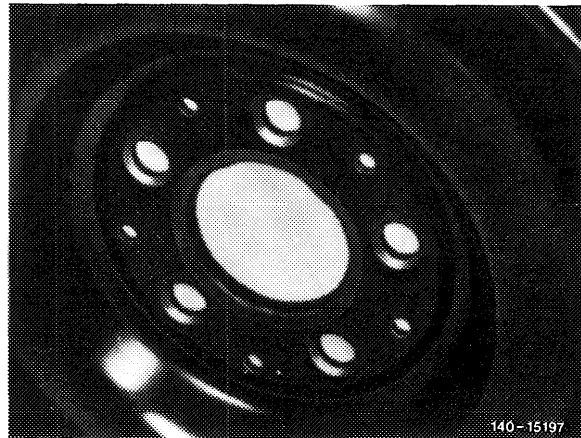

2nd version
Wheel with raised
fastening eyes

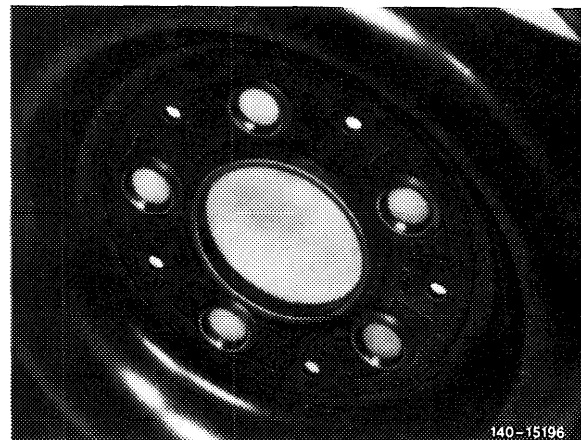

Wheels with reduced inside spacing in relation to contact surface caused by often, excessive tightening of spherical collar bolts should no longer be mounted.

On a removed wheel, the distance between the contact surface and the range of the fastening eyes should amount to at least 0.7 mm. For measuring, use a straightedge and a sliding caliper with depth gage.

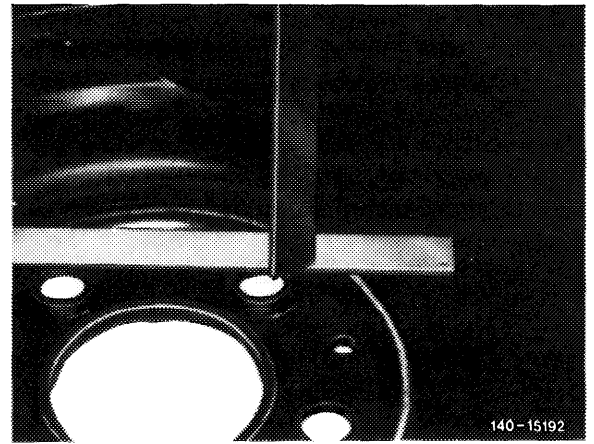

140-15192

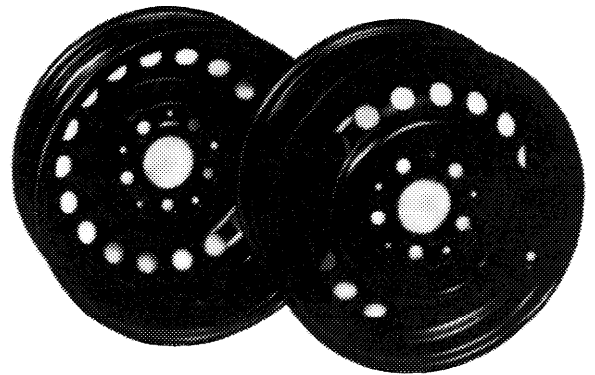

Steel plate rim
5 J x 14 H 2
without inner venting ring
wheel disk with 18 vent holes
of 20 mm dia.

140-23735

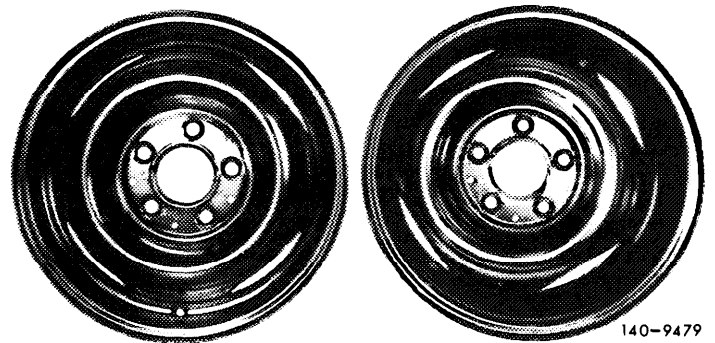

Steel plate rim
5 1/2 J x 14 H 2
(version up to September 1977)

140-9479

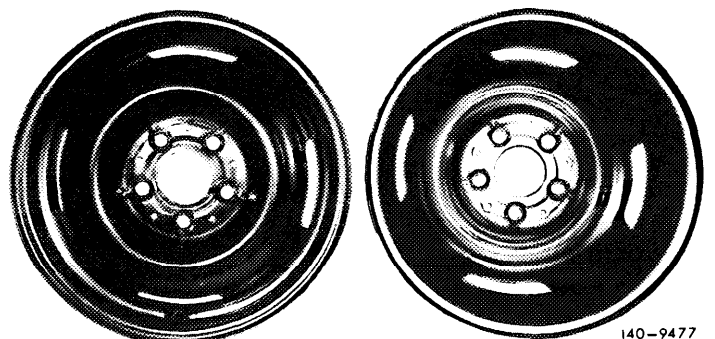

Steel plate rim
5 1/2 J x 14 H 2
(version starting October 1977)

140-9477

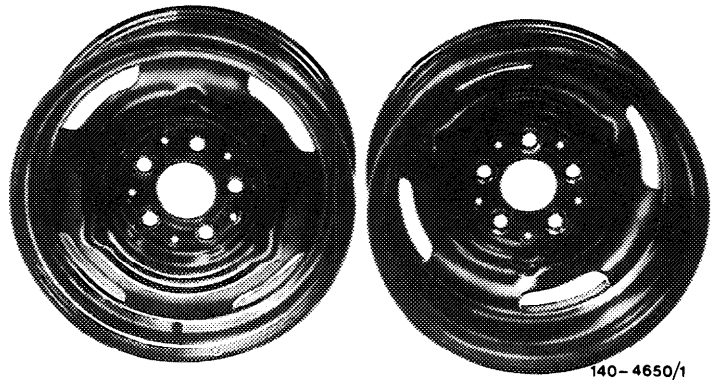

140-4650/1

Steel plate rim
6 J x 14 H 2
(version up to December 1969)

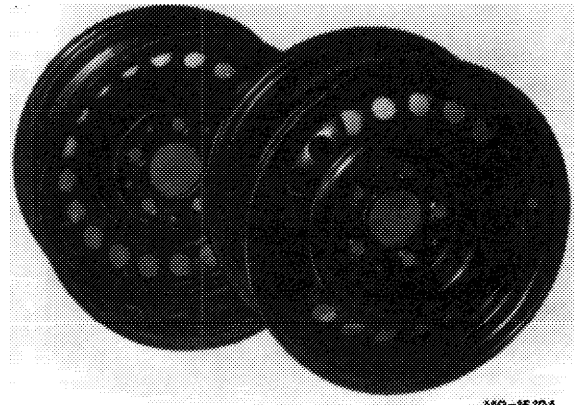

140-15124

Steel plate rim
6 J x 14 H 2
without inner venting ring
Wheel disk with 20 vent holes of 28 mm dia.
(version starting January 1970 up to October 1981)

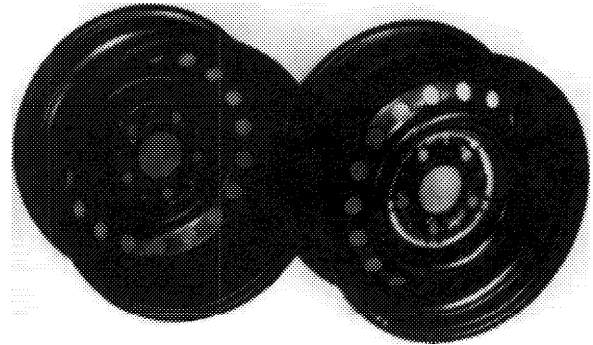

140-21545

Steel plate rim
6 J x 14 H 2
without inner venting ring
Wheel disk with 18 vent holes of 25 mm dia.
(version starting November 1981)

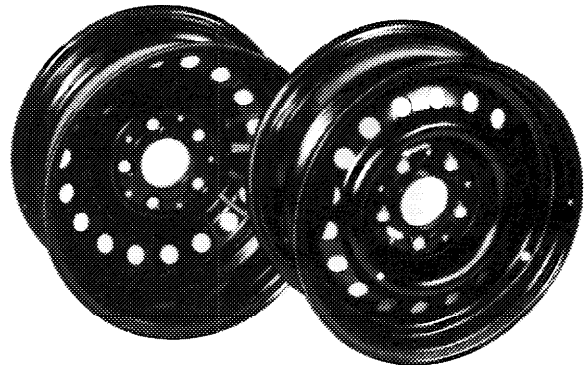

140-20049

Steel plate rim
6 J x 14 H 2
with inner venting ring
Wheel disk with 18 vent holes of 25 mm dia.

USA light alloy rims

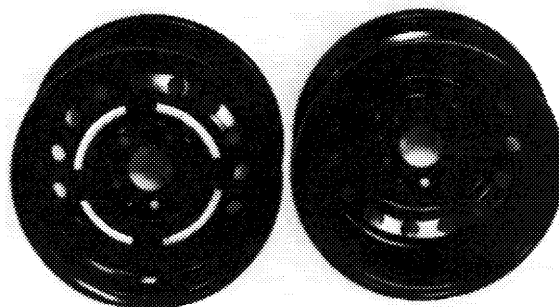

Light alloy rim
5 1/2 J x 14 H 2

140-17054/1

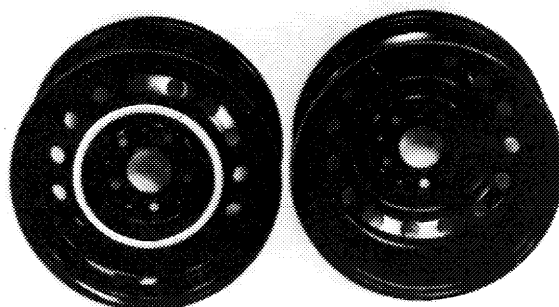

Light alloy rim
6 J x 14 H 2

140-17054

Forged light alloy rims

The rim flanges of light alloy rims may show increased wear under the following operating conditions: high load, trailer operation, not enough tire inflation pressure, use of unrecommended tire makes or tire versions, accumulation of dirt, sand and road salt (particularly during winter months). Prior to mounting a new tire, check rim flanges for wear. Remove burr, if any. Replace rim as soon as wear limit is attained (40-120).

Particularly during the six winter months, check rims inside for contamination and clean, if required.

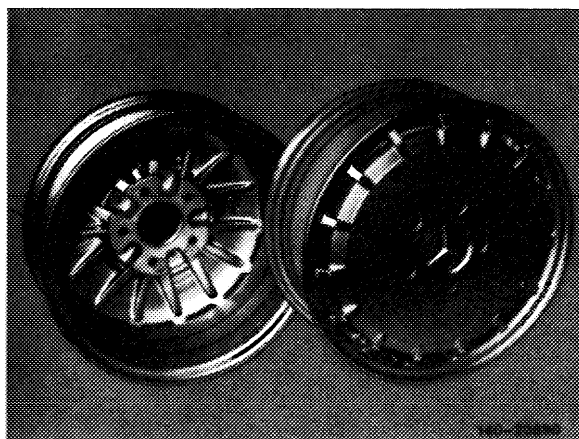

Forged light alloy rim
5 J x 14 H 2

40.5-102/8 F 2

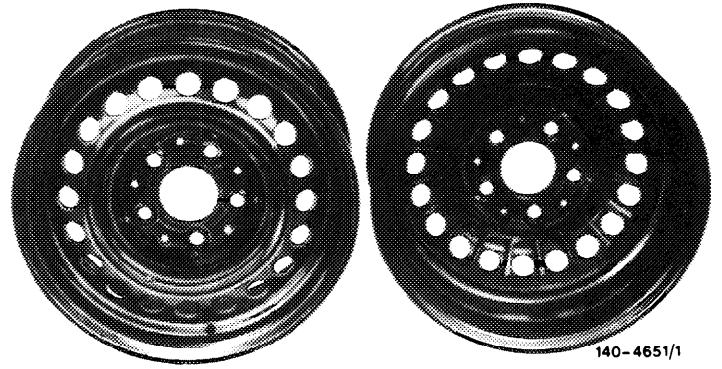

Steel plate rim
6 1/2 J x 14 H 2
with inner venting ring
Wheel disk with 20 vent
holes of 28 mm dia.
(version up to December 1979)

140-4651/1

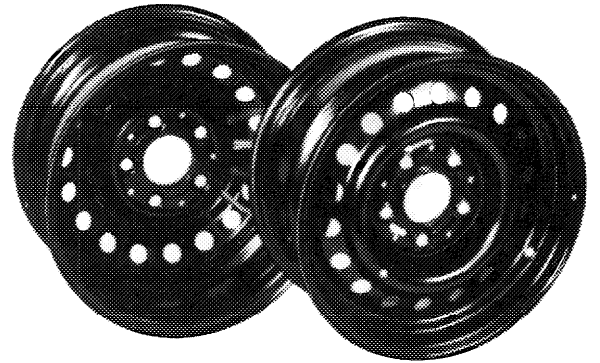

Steel plate rim
6 1/2 J x 14 H 2
with inner venting ring
Wheel disk with 18 vent holes of 25 mm dia.
(version starting January 1980)

140-20049

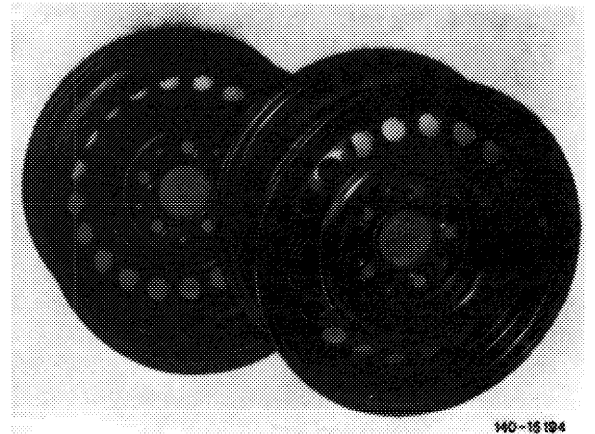

Steel plate rim
6 1/2 J x 14 H 2
without inner venting ring
Wheel disk with 18 vent
holes of 25 mm dia.

140-15104

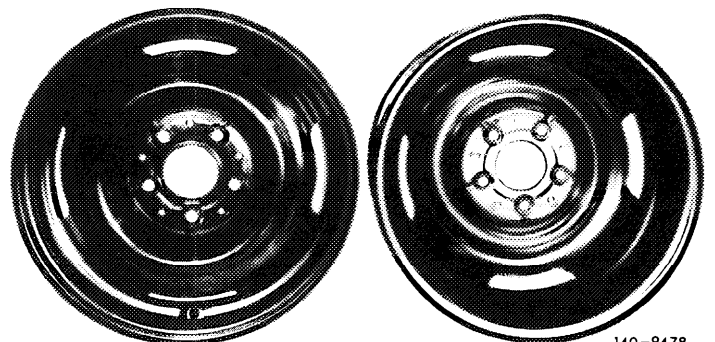

Steel plate rim
5 1/2 J x 15 H 2

140-9478

Forged light alloy rim
5 1/2 J x 14 H 2, 6 J x 14 H 2, 6 1/2 J x 14 H 2,
7 J x 15 H 2

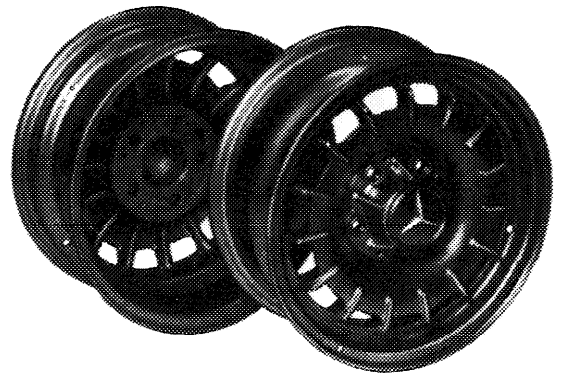

140-15195

Version up to September 1981
(**wihout** cavity on valve seat –
for special metal valve)

Version starting October 1981
(**with** cavity on valve seat –
for rubber valve)

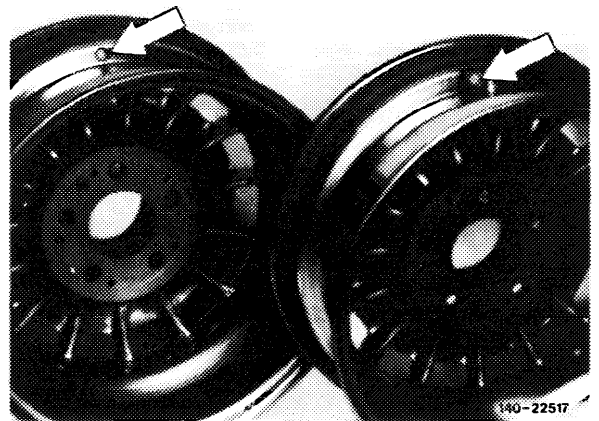

140-22517

Upkeep and cleaning of forged light alloy rims

Light alloy rims are coated with a special metallic paint. For this reason, they must be serviced and cleaned with paint-protecting compounds only, just like the vehicle body. Any damage to clear paint surface may lead to peeling.

For this reason, the following instructions should be observed and maintained for upkeep and cleaning.

1. Never treat light alloy rims with abrasive compounds, compounds or sponges which are containing acids or are heavily alkaline. High-pressure hot-water cleaning units should also not be used.

2. Depending on accumulated dirt, clean wheels once a week, whenever possible. Normal dirt including abrasive dust from brake linings can be removed with lukewarm water, a mild solvent for removing dirt (of the type used for cleaning vehicle body) and a sponge. Also use lots of water.

If the wheel cleaning job in combination with a normal vehicle wash is not enough, special preserving and cleaning compounds for light alloy rims are now available (used after precleaning with water).

If repainting of light alloy rims is required, refer to paintwork repair instructions.

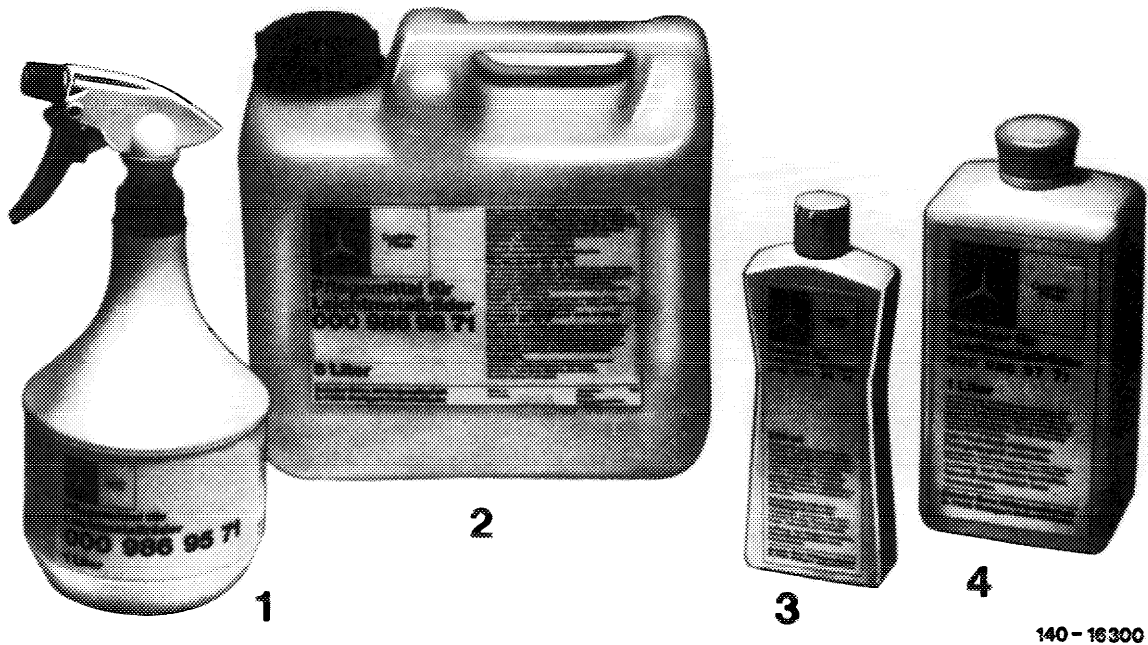

Service compounds and cleaners for light alloy rims

- | | |
|-------------------------------------|----------------------------------|
| 1 Spray bottle (1 liter) | 3 Bottle (1/4 liter) |
| 2 Canister – refill pack (5 liters) | 4 Bottle – refill pack (1 liter) |

Materials

Designation	Container size	Part No
Service compound for light alloy rims	1-liter spray bottle	000 986 95 71
	5-liter canister	000 986 98 71

For regular treatment of rims, also if heavily contaminated, but not for tightly sticking residual dirt. Compound has preserving effect.

Cleaner for light alloy rims	1/4 liter bottle for approx. 5 treatments	000 986 94 71
	1-liter bottle	000 986 97 71

For removing tightly sticking dirt which cannot be removed with our service compounds for light alloy rims. After a cleaning job with this compound a subsequent preservation with gloss preservation 000 986 06 74 or service compound for light alloy rims 000 986 95 71 must be performed.

Rims

Model year	Material	Dimensions	Part No
1984	Alloy	5 x 14	201 400.07 02
1985	Alloy	5 x 14	201 400 07 02
	Steel	5 x 14	201 40005 02
1986	Alloy	6 x 15	201 400 12 02
			201 400 1402
1987	Alloy	6 x 15	201 400 15 02
			201 400 16 02

Note

Use only tires recommended by us. Pay attention to our tire recommendations particularly with regard to light alloy rims.

As replacements or for a conversion, use tires of similar construction, similar make and similar version for all rims. We do not approve combination of belted tires (radial) with conventional tires (diagonal), steel belted tires with textile belted tires, as well as winter tires (M + S) with summer tires.

In the event of replacements, tires approved for higher speeds may of course be used instead of the tires specified for the respective model (example: belted tires 195/70R 14 90 H instead of 195/70R 14 90 S).

When replacing tires, include spare wheel as a road wheel, but only if depth of tire treads and tire version are similar. Avoid excessive ageing of tires!

New tires should be run in prior to demanding full efficiency. About 100 km driven at moderate speed are enough. Avoid sharp acceleration and braking.

Storage areas for keeping tires in stock should be dark, cool and dry. Avoid drafts as much as possible, since oxygen accelerates ageing of rubber compound.

Place tubes upright in shelf (min. 10 cm ground clearance) or in sets one upon the other on wooden gratings.

On removed tires, put tubes into tires lightly inflated and dusted with talcum, make sure that tires are not coming into contact with gasoline, oil or technical greases.

Apply safety rules as a protection against fire!

If vehicles are converted to a different tire size than the one ex factory, pay attention to national laws and regulations prior to conversion.

For tube type tires use only new tubes of the same make and specified designation.

For tubeless tires, insert valves of specified version into rims (refer to 40-l 20).

When renewing a tire, also exchange rubber valve as a safety measure. Prior to inserting the new rubber valve, clean contact surfaces on rim. If required, de-rust surfaces and re-paint.

Screw only metal or rigid plastic valve caps with rubber sealing rings, part no. 007757 008600, on valves.

Tire designation

1 Tire designation

Example:

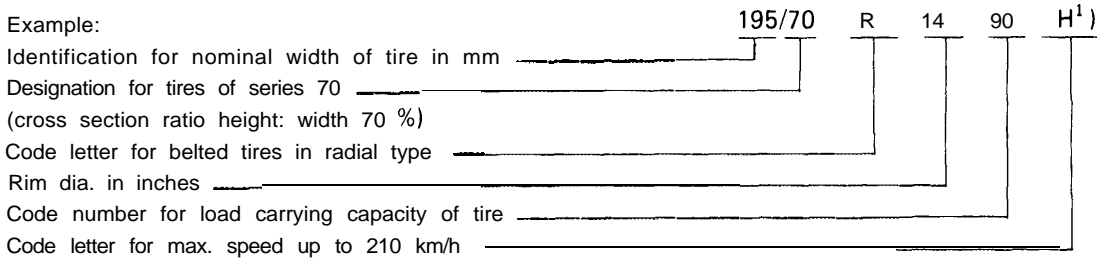

¹) For designation of tires according to ECE-regulation no. 30 (starting 1978), with the exception of VR-version tires, the operational identification, that is, the code letter for the permissible max. speed and the code number for load carrying capacity is named following the tire designation. The former designation of tire was 195/70 HR 14 or as a temporary designation 195/70 HR 14 90 H.

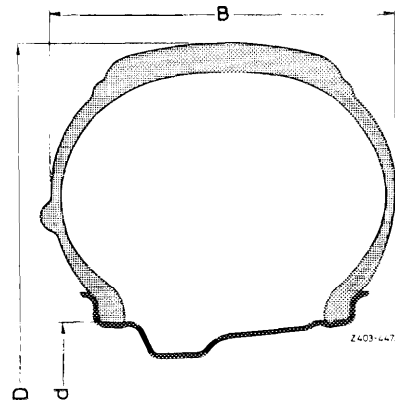

B = Nominal width of tire in mm
D = Tire OD
d = Rim dia. in inches

2 Additional tire designations

Radial = designation for belted tires
tube-type = tube-type tires or assembly with tube
tubeless = tubeless version tires
M + S = mud and snow tires

3 Indication of manufacturing country

4 Country code number for licence number

Example:

3 = Italy, 1 = Germany, 2 = France.

0132239 = registration number for type or model test

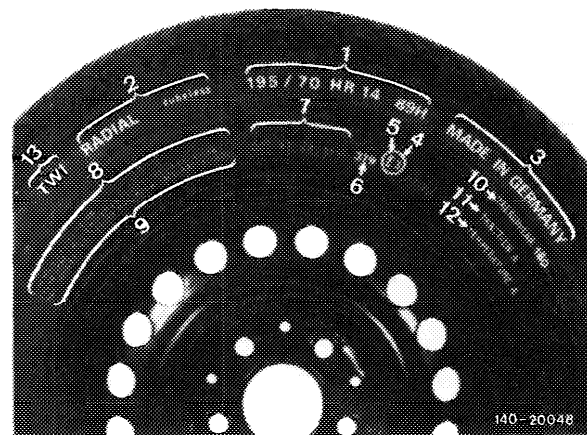

5 Europe licence number

E = Europe

6 Production date code number

The 3-digit code or production code number is at end of letter and number sequence beginning with DOT and located in bead range of outer tire flanc.

Number 1 and 2 = production week

Number 3 = last digit of production year

7 **USA** licence number

DOT = Certificate of Department of Transportation

XT = Manufacturer's code

J9 = Size code

XKNC = Type or version code

8 **USA** identification for tire understructure

Example:

SIDEWALL 2 PLIES RAYON = Sidewall of carcass comprises 2 layers rayon cord.

TREAD AREA 2 PLIES RAYON + 2 PLIES STEEL + 1 PLY NYLON = Tread zone has 2 layers rayon cord of carcass and 2 layers steel cord + 1 layer Nylon of belt.

9 **USA** identifications for max. wheel load and max. air pressure

Example:

MAX. LOAD RATING 1340 LBS =

max. permissible wheel load 1340 pounds

MAX. PERM. INFL. PRESS 36 PSI =

Max. permissible air pressure 36 pounds per square inch

10 **USA** identification for tread wear

TREAD WEAR 160 = Wear code number in % as compared with an average US comparison tire.

11 **USA** identification for anti-skid properties

TRACTION A = Identification for deceleration on wet asphalt and concrete.

12 **USA** identification for temperature stress

TEMPERATURE A = Identification for temperature behavior during fast dynamometer run

13 Tire wear limit

The wear limit of 1.6 mm for tire tread specified for USA and lately for other countries has already been indicated for a number of years by the "TWI" tread wear indicator on tire.

These humps are 1.6 mm high and embedded in base of tread at 6 points of circumference and will show up as cross stripes on tread when the wear limit is attained.

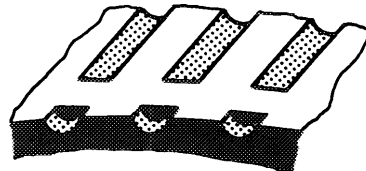
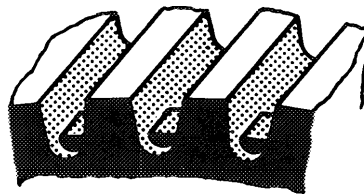

1404-6058

Permissible max. speed for passenger car belted tires (radial)

Code letter Q up to 160 km/h
Code letter R up to 170 km/h
Code letter S up to 180 km/h
Code letter T up to 190 km/h
Code letter H up to 210, km/h
Code letter V above 210 km/h

Sticker for M + S tires

Regulations in the Federal Republic of Germany are specifying that the legally permitted maximum speed for M + S tires "should be clearly displayed within view of driver", if the max. speed permitted for M + S tires is below the max. speed of the vehicle (refer to vehicle documents).

This sticker may be attached to the spot specified for this purpose only. On models 123 and 126 do not place this sticker on glass of instrument cluster, since this glass may be damaged when the residual glue is removed (plexiglass).

Sticker for M + S tire version
Q = up to 160 km/h

Sticker for M + S tire version
T = up to 190 km/h

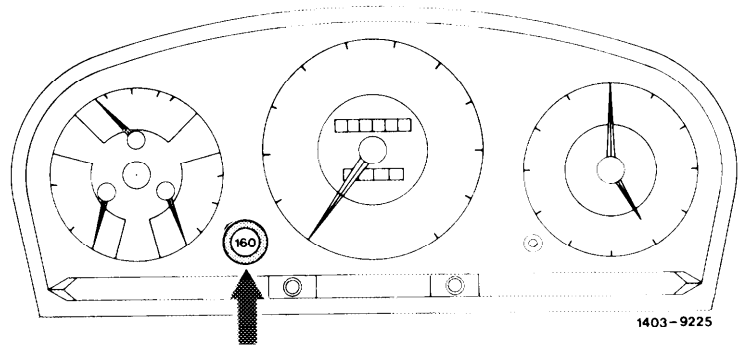

Models 107, 116

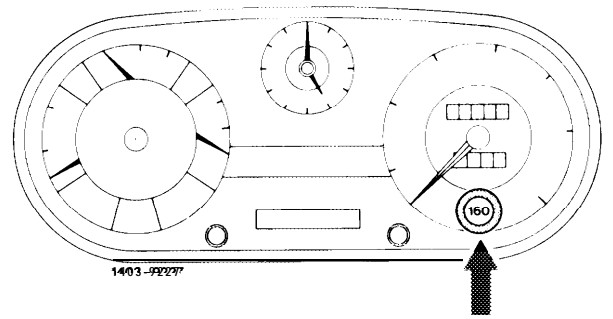

Models 114, 115

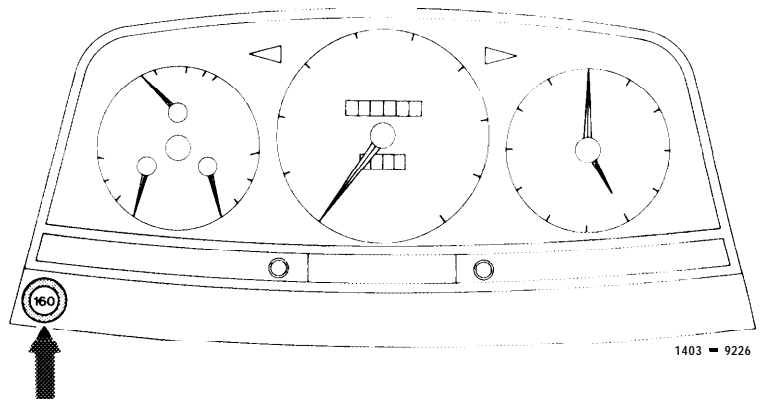

Model 123

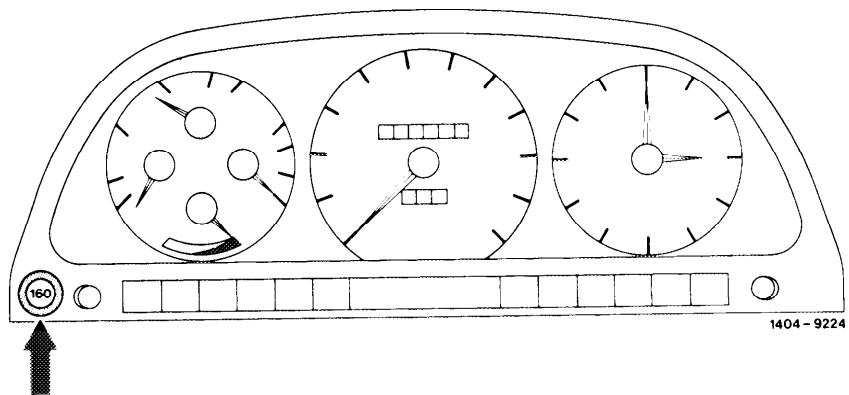

Model 126

Model 201

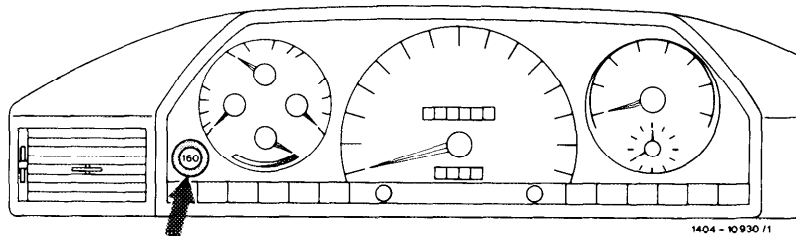

Tire wear

When evaluating tire wear patterns proceed as follows:

Front axle

On front wheels, a slightly higher wear of tire shoulders as compared with center of tread is normal, while the wear on tire shoulder facing the road center (e.g. with righthand traffic on outside of **left**-hand wheel, on inside of righthand wheel) may be more distinctive.

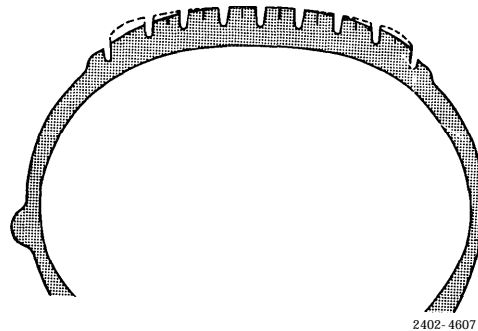

Causes of increased tire wear

1. Not enough inflation pressure, influencing both outer and inner shoulder to the same extent.
2. Predominantly city or highway driving, as well as sports style driving. The habit of driving around sharp bends while decelerating may lead to increased shoulder wear. Wear occurs mostly on outer shoulders, with righthand traffic particularly more clearly at **lefthand** front wheel.
3. Deviations of toe-in. Even minor deviations beyond normal tolerance range may lead to increased wear on tire shoulders, particularly on white tires (starting with series **70**) each time on both wheels. At insufficient toe-in, increased wear will show up on inner shoulders or at increased toe-in on outer shoulders. In the event of toe-in deviations, which are clearly exceeding the tolerance limits, the wear may extend from tire shoulder almost to center of tread, in which case the tread may be slightly roughened.

If deviations of pivot point position from nominal value are too high, increased shoulder wear may occur on both wheels as well as on one wheel only, since changes of toe-in during deflection will be too high. A pivot point which, for example, is substantially too low will lead to an increased change of track in minus direction during downstroke, while a pivot point which is substantially too high will lead too early to a change of track in minus direction during upstroke.

If the track difference angle deviates too much, an unfavorable wheel position may result in influences which lead to increased shoulder wear.

4. In dependence of tire version and tire tread, the wear on shoulders, predominantly outside, may have a **saw-toothed** shape. This wear pattern is particularly distinctive on tires with a shoulder zone open in outward direction, e. g. sports style summer tires and M + S tires.

Saw tooth-shaped wear occurs predominantly on front axle, but to a lesser degree also on rear axle.

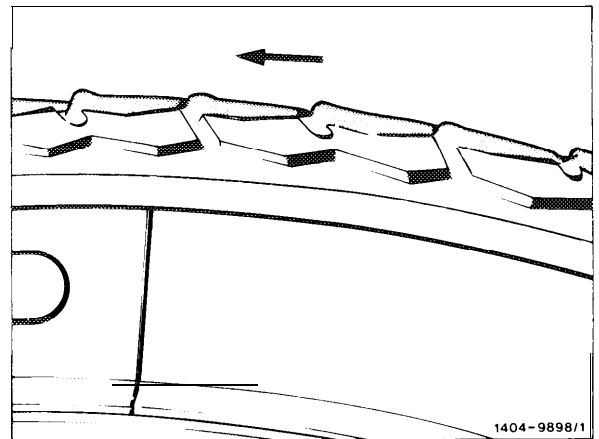

Saw tooth-shaped wear on front wheel tires

Rear axle

On rear wheels, wear is normally distributed across entire tire tread surface, but may be slightly higher in tread center than at the shoulders.

Causes of increased wear

1. Depending on load of vehicle rear end (on vehicles without level compensation increased minus camber at high load) wear on inner side of tread is higher than on outer side.
2. If toe-in is wrong, the same applies as explained in section "front axle".

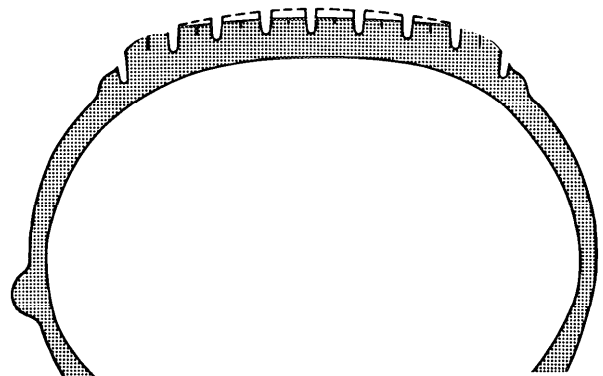

Rotation (switching) of wheels

Summer tires and winter tires (M + S):

For max. mileage while simultaneously maintaining good driving characteristics.

Rotate (switch) wheels depending on tire wear (that is, between 5000 and 10,000 km as shown by experience) while keeping driving direction of wheels the same.

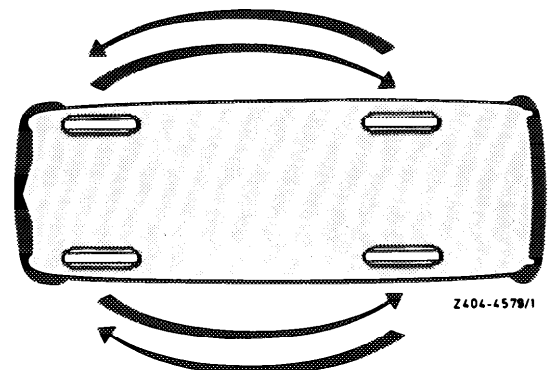

However, the wheels should be rotated (switched) prior to attaining a distinctive, characteristic wear pattern, since otherwise driving characteristics will turn to the worse. Optimal driving characteristics, in turn, can be obtained only if the wheels are left in their position or are rotated (switched) at very short intervals (mileage).

Rebalancing of wheels may be required depending on driving style, wear pattern and condition of tires.

Upon rotation (switching) of wheels, make sure of correct tire inflation pressure.

Note

The tire inflation pressure specified by vehicle manufacturer is determined in accordance with the following criteria:

1. Consideration of axle loads on vehicle under influence of full load.
2. Consideration of attainable max. speed of respective vehicle.
3. Good driving characteristics, also for sports-style driving.
4. Satisfactory driving comfort.
5. Favorable tire wear pattern.

A wrong tire inflation pressure, particularly when the air pressure is too low, will influence the driving characteristics and the life of the tires depending on extent of deviation from specified value, and will also lead to an additional, higher fuel consumption.

If the tire inflation pressure is too low, flexing and thereby excessive heating will increase. The understructure of such a tire will lose its compactness. The results: tread and belt will come loose. Depending on size of reduced inflation pressure and driven speeds, the life of the tire will become shorter, while even short-term "inflation pressure sins" may lead to permanent damage.

On the other hand, a tire inflation pressure which is essentially too high (higher than the values named for fast driving or for max. loads) incorporates the disadvantages of a high loss in comfort, while the smaller tire road contact area results in a worsening of driving characteristics and on a wet road also in a higher trend toward aquaplaning.

Notes concerning tire inflation pressure checkup

1. Check inflation pressure of tubeless tires every two weeks.

On tube-type tires, checking inflation pressure once a week will be of advantage.

2. Measure inflation pressure as much as possible when tires are cold, while taking the respective outside temperature into account. Here, approx. 10 °C are equal to an air pressure change by 0.1 bar.

Example 1

The specified air pressure is valid if the temperature of the tires is in accordance with outside temperature.

Example 2

If the temperature of the tires is equal to room temperature (ambient temperature) e. g. +20 °C, and the outside temperature amounts to approx. 0 °C, the tire inflation pressure must be set 0.2 bar higher than the specified air pressure.

3. if the inflation pressure is measured on warm tire, an increase up to 0.5 bar must be taken into consideration depending on extent of heating up caused **for example by fast driving on a highway, by hot weather or by exposure to sunshine. Following normal driving, the increase in air pressure will amount** to approx. 0.2 bar.

Never deflate warm tire.

4. If an inflation pressure checkup on a single wheel will always show a higher drop in inflation pressure than on the other tires, the respective wheel should be checked.

The following causes may be responsible:

- a) Penetration of foreign bodies.
 - b) Damaged tread or side wall.
 - c) Leaking valve bodies or valve elements (refer to item 4).
 - d) On tubeless tires leak between tire bead and rim.
 - e) On tube-type tires, leaking inner tube.
 - f) On tubeless tires leaking rim e. g. crack in welding seam or faulty welding on steel plate rims or porous spot on cast light alloy rims (products from other manufacturers).
5. If the valve cap is not screwed on again following a tire inflation pressure checkup, penetrating dirt may settle at edge of valve element during next inflation pressure checkup and will subsequently result in a creeping inflation pressure loss.
6. Use only metal valve caps or valve caps made of hard (rigid) plastic material with rubber sealing ring recommended by us. In contrast to caps made of soft plastic material, these caps guarantee additional sealing in the event of a leaking valve element.

- 1 Valve body
- 2 Valve element
- 3 Valve cap with rubber sealing ring

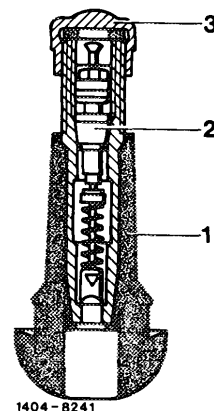

Cold tire inflation pressures

Model	Load	Front pressure bar/psi	Rear pressure bar/psi
201.024	Partial	2.0/29	2.2/32
	Max	2.2/32	2.5/36
201.034	Partial	2.2/32	2.4/35
	Max	2.4/35	2.8/41
201.028	Partial	1.8/26	2.0/29
	Max	2.0/29	2.3/33
201.029 (MY1987)	Partial	1.8/26	2.0/29
	Max	2.0/29	2.3/33
201.029 (MY1988)	Partial	1.9/27	2.0/29
	Max	2.0/29	2.3/33
201.122	Partial	1.8/26	2.0/29
	Max	2.0/29	2.3/33
201.126	Partial	1.8/26	2.0/29
	Max	2.0/29	2.3/33
201.128	Partial	1.8/26	2.0/29
	Max	2.0/29	2.3/33

Tire inflation pressure labels

Model	Part Number	Color Base/Letters
201.024	201 584 05 39	red/silver
201.034	201 584 13 39	silver/red
201.028	201 584 05 39	red/silver
201.029 (MY 1987)	201 584 05 39	red/silver
201.029 (MY1988)	201 584 22 39	silver/red
201.122	201 584 05 39	red/silver
201.126	201 584 05 39	red/silver
201.128	201 584 05 39	red/silver

40–108 Snow chains

Remove wheel caps.

Retention snow chains after driving for a short distance!

When driving with snow chains, do not exceed max. speed of 50 km/h!

On roads free of snow, drive with restraint for safety reasons and to protect chains.

Mercedes-Benz non-skid chains with gripping studs

(up to 1982)

Tire size	Part no.	Code no. ¹⁾
175 R 14	000 583 66 16	07 325
185 R 14	000 583 66 16	17 328
195/70 R 14	000 583 89 16	16 327
205/70 R 14	000 583 81 16	16 329
215/70 R 14	000 583 88 16	16 331
185 R 15		



140–18612

Mercedes-Benz nonskid chains with gripping studs

RUD-matic system (starting 1983)

Tire size	Part no.	Code no. ¹⁾
175/70 R 14	201 583 00 16	46 320
175 R 14	123 583 00 16	46 325
185 R 14	1075830016	46 328
195/70 R 14		
205/70 R 14	1265830016	46 329
215/70 R 14	1165830016	46 331
185 R 15		
205/65 R 15	107 583 01 16	46 384

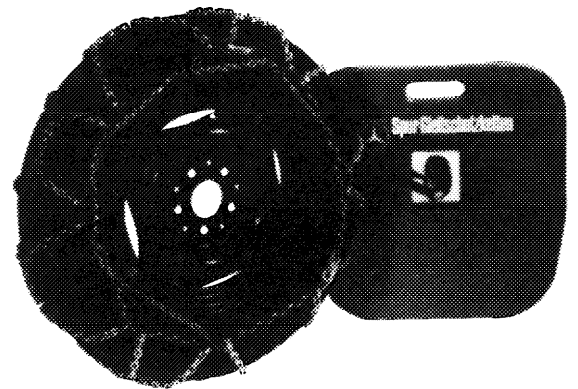

140–25705

**Mercedes-Benz non-skid chains without gripping studs
RUD-matic system (starting 1983)**

Tire size	HW-part no.	Code no. ¹⁾
175/70 R 14	758 0265	44 320
175 R 14	758 0266	44 325
185 R 14	758 0267	44 328
195/70 R 14		

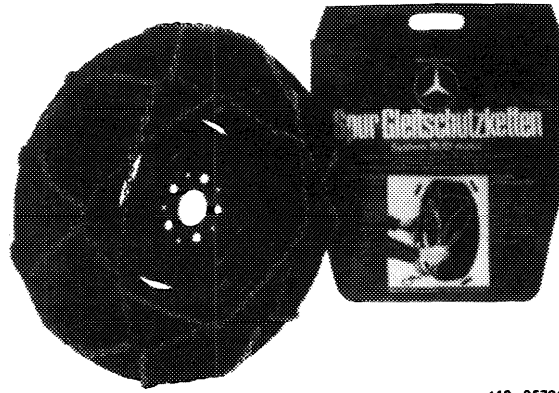

140-25706

**Additionally recommended non-skid chains
Erlau-Quadrat-m (up to 1982)**

Tire size	Part no./code no. ¹⁾
175 R 14	417-048
185 R 14	417-056
195/70 R 14	417-059
205/70 R 14	417-057
215/70 R 14	417-054
185 R 15	417-061

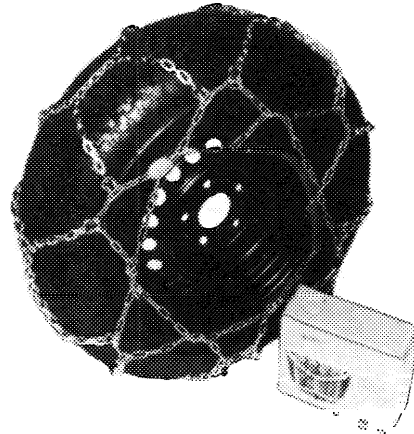

140-18613

Milz ring chain

Tire size	Without gripping studs Y-grip pattern code no. ¹⁾	With gripping studs Y-super grip pattern code no. ¹⁾
175/70R 14	60 or 20 060	—
175 R 14	70 or 20 070	23 070
185 R 14 195/70 R 14	80 or 20 080	23 080
205/70 R 14	90 or 20 090	23 090
215/70 R 14	100 or 20 100	23 100
165 R 15	90 or 20 090	23 090
205/65 R 15	90 or 20 090	23 090

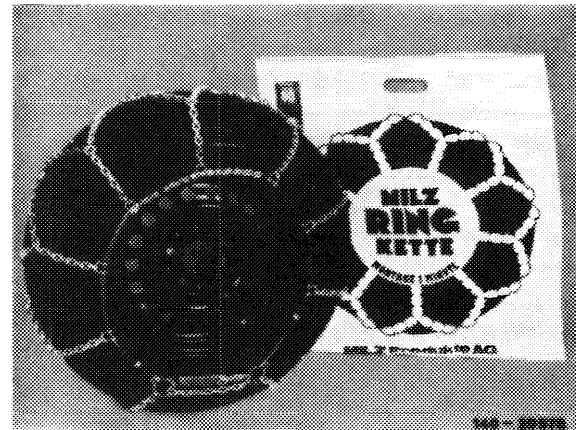

140-23090

RUD-“non skid” (up to 1982)

Tire size	Part no.¹)
175 R 14	07125
185 R14	17 128
195/70 R14	16 127
205/70 R 14	16 129
215/70 R 14	16 131
185 R 15	



140-22908

**RUD-matic
type “non-skid” (starting 1983)**

Tire size	Part no.¹)
175/70 R 14	46 120
175 R 14	46 125
185 R 14 195/70 R 14	46128
205/70 R 14	46 129
215/70 R 14	46 131
185 R 15	46 131
205/65 R 15	46 184



140-25707

¹) Code numbers or part numbers are each stamped-in at closing hook of tensioning chain or at outer (red) steel rope ring.

40-110 Removing and mounting of wheels

Wheel bolts for fastening wheel

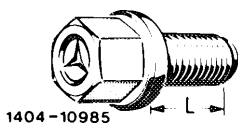
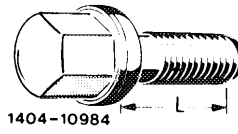
Part no.	Threads	Length "L"	Type	
For steel plate and light alloy rims')				
110 401 01 70	M 12 x 1.5	21	107 114 115 116 123 126 201	
For forged light alloy rim ²⁾				
108 401 00 70	M 12 x 1.5	29.5	107 114 115 116 123 126 201	

¹⁾ A Mercedes star is stamped into face of screw head for identification as an MB original part.

²⁾ A Mercedes star is stamped into face of threaded part for identification as an MB original part.

Centering of rims

Centering on rim dia.	Centering on front wheel hub or on rear axle shaft flange	Radial play between rim and front wheel hub or rear axle shaft flange')
66.50	66.40	0.10
66.57	66.35	0.22

¹⁾ Checking wheel centering play.

Check centering bore of rim for burr, if any.

The wheel play between rim and front wheel hub or rear axle shaft flange should not exceed 0.2 mm. Reduce higher play by spraying quick-drying paint from a spray can against wheel center (refer to arrow), covering wheel contact surface for this purpose (refer to 40-1 30).

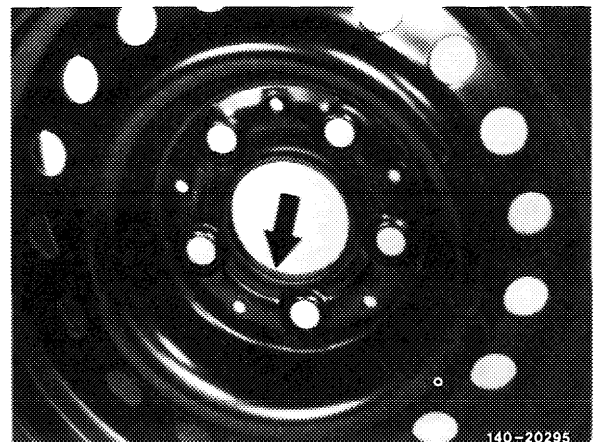

Steel plate rim

140-20295

Forged light alloy rim

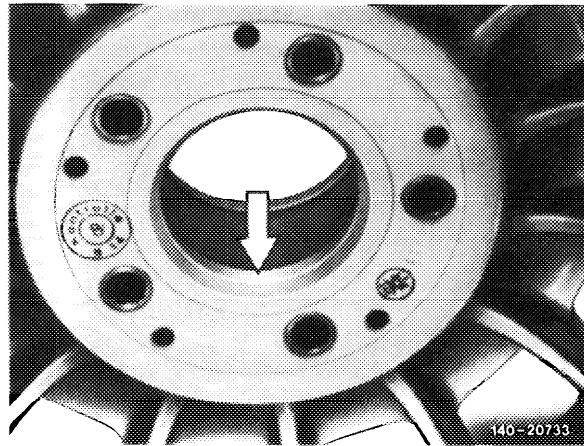

Tightening torque

Nm

Wheel bolts for fastening wheel

110

Assembly bolt for forged light alloy rim¹⁾

Model	Part no.	Threads	Length "L"	
201	201 400 00 74 ¹⁾	M 12 x 1.5	80	

¹⁾ On light alloy rims, prior to mounting wheel, screw assembly bolt available with spare wheel into screw hole located at the top.
²⁾ Spare parts scope of delivery includes: Assembly bolt and rubber sleeve (rubber sleeve serves for fastening bolt in spare wheel).

Conventional tools

Electric or pneumatic impact wrench
with limited tightening torque of 100 Nm

e.g. Atlas-Copco
D-7250 Leonberg
order no. LMS 26 HR 01

Hex. socket for impact wrench,
OD max. 26.5 mm

e.g. Hazet
D-5630 Remscheid
order no. 900 S

Torque wrench, automatically releasing

e.g. Rahsol
D-5650 Solingen
order no. 7562-I

Wheel attachment

Never mix up spherical collar bolts for steel plate and light alloy rims with spherical collar bolts for forged light alloy rims.

Check spherical collar bolts. Clean dirty bolts. Replace screws with damaged threads, worn zinc layer on spherical collar and with corroded spherical collar. Check threads in front wheel hub and rear axle shaft flange for easy operation and refinish, if required.

There should be no dirt or grease on spherical collar of bolts as well as on spherical segments of rims, since otherwise the threads of the spherical collar bolts and of front wheel hub or rear axle shaft flange will be excessively strained.

Contact surfaces on rim and front wheel hub or on brake disk bowl must be clean. Clean corroded surfaces with wire brush or emery cloth.

Always tighten spherical collar bolts with torque wrench on principle.

Check torque wrench regularly.

Re-tighten new rims after a mileage between 100 and 500 km. The reason for this requirement is the setting of the spherical sections for wheel fastening.

Steel plate and light alloy rim

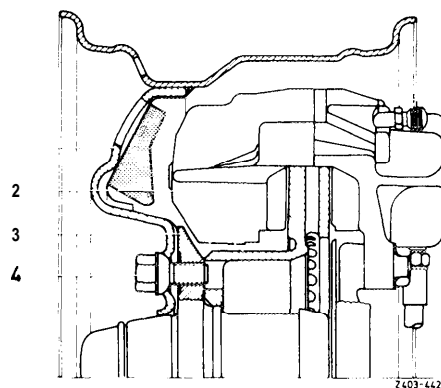

Forged light alloy rim

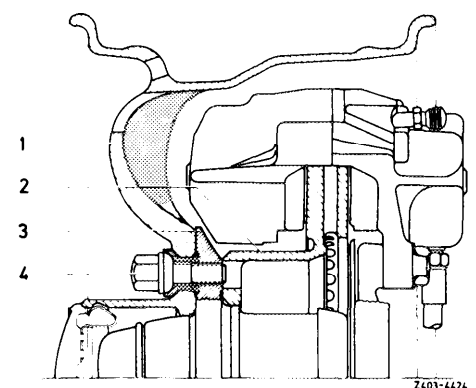

**Wheel attachment
front axle**

- 1 Rim
- 2 Brake disk
- 3 Front wheel hub
- 4 Spherical collar bolt

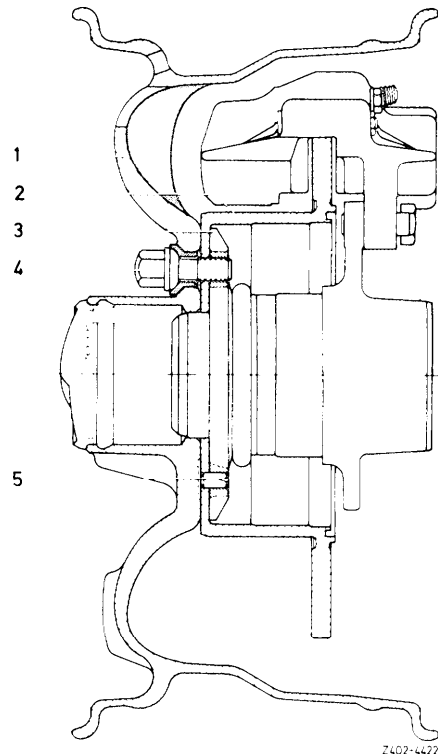
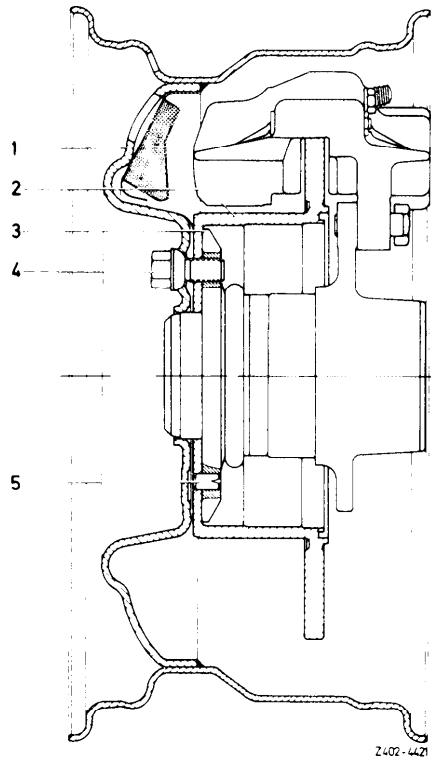

Wheel attachment rear axle

- 1 Rim
- 2 Brake disk
- 3 Rear axle shaft flange
- 4 Spherical collar bolt
- 5 Fitted pin for locating brake disk

Z402-4421

Z402-4422

Note

On model 201 with forged light alloy rims use assembly bolt available with spare wheel for mounting wheel.

- 1 Spare wheel
- 039 Assembly bolt
- 039a Rubber sleeve

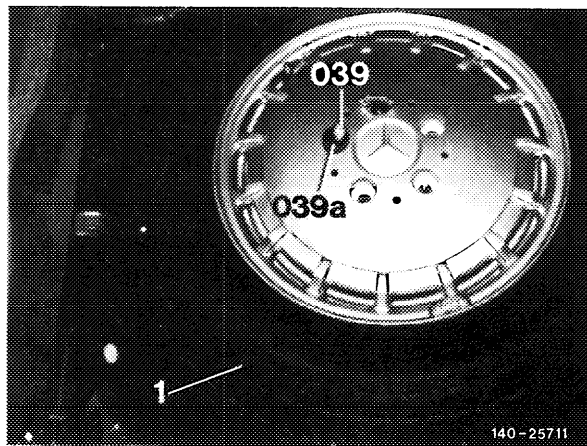

140-25711

Prior to mounting wheel, screw assembly bolt into tapped hole located at top (arrow).

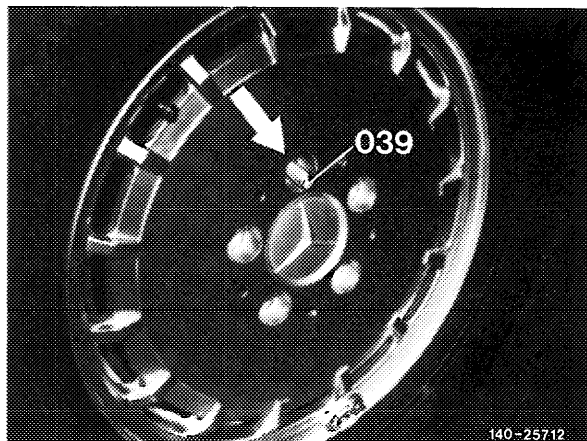

- 039 Assembly bolt

140-25712

Make sure that the wheels are not distorted by **one-sided** tightening of spherical collar bolts.

Tighten spherical collar bolts crosswise in several steps.

Make particularly sure that the first wheel bolt is not already tightened to its full tightening torque prior to at least screwing-on the others.

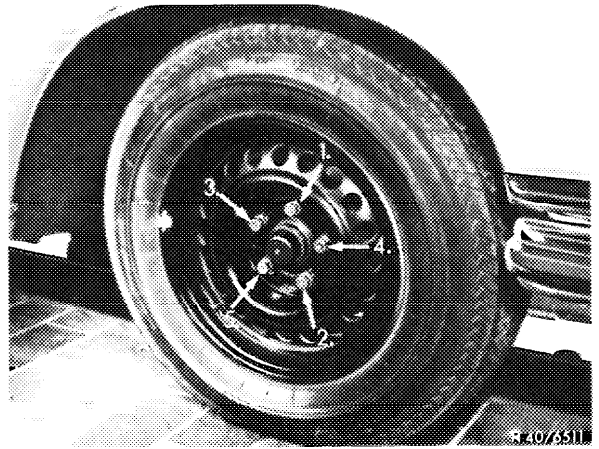

When using impact wrenches, tighten only up to appr. $\frac{3}{4}$ of the required torque, then tighten with torque wrench while not exceeding specified value.

Experience has shown that impact wrenches will already obtain a tightening torque of 60 to 70 Nm under a single impact. When impacts continue, some impact wrenches may already have established an essentially excessive tightening torque, which may lead to a deformation of rim, damage to threads or fracture of spherical collar bolts.

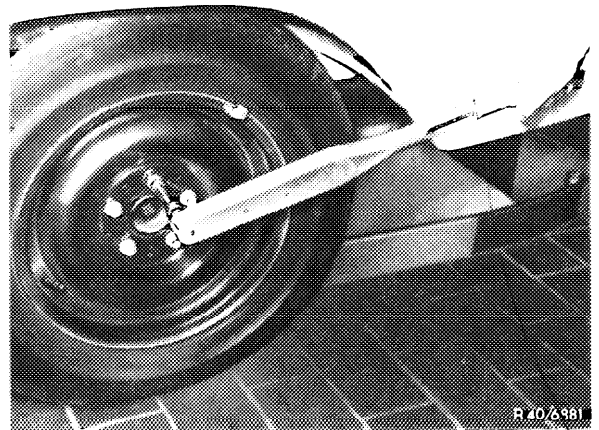

On forged light alloy rims, the OD of the wheel wrench or socket wrench element for impact wrench may amount to max. 26.5 mm, since otherwise hub of wheel may be damaged. When unscrewing last spherical collar bolt, make sure that the wheel is not tilting, since otherwise the paint on wheel hub may suffer damage.

For tightening spherical collar bolts, use a torque wrench with automatic release (click wrench).

Ventilated rims are subject to a high air flow. Prior to mounting rim, check wheel disk for contamination and clean, if required.

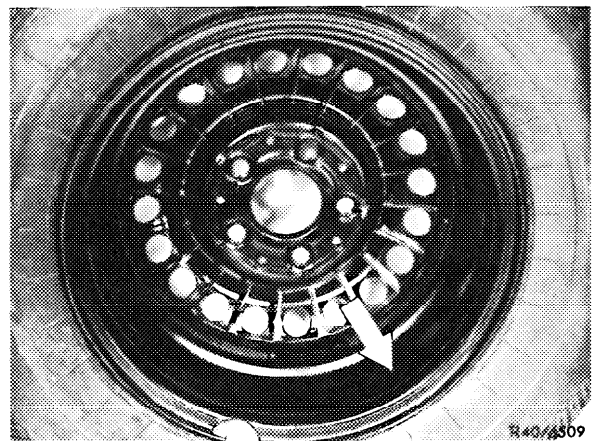

Steel plate rim

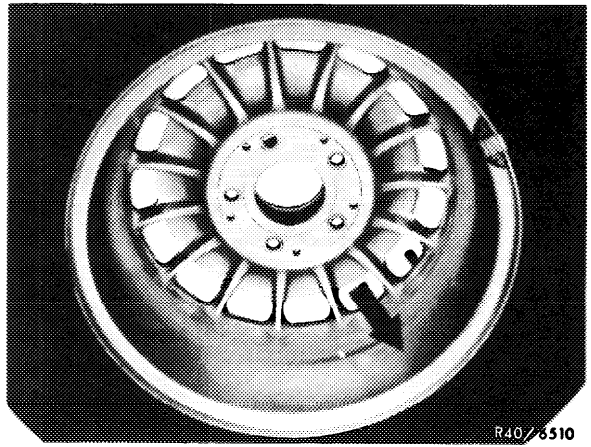

Forged
light alloy rim

R40/6510

40-113 Removing and mounting hub cap for forged light alloy rims

The hub cap serves for covering rim hub.

B. Model 201

The plastic hub cap (6) is fastened in rim hub by means of three holding cams (6a).

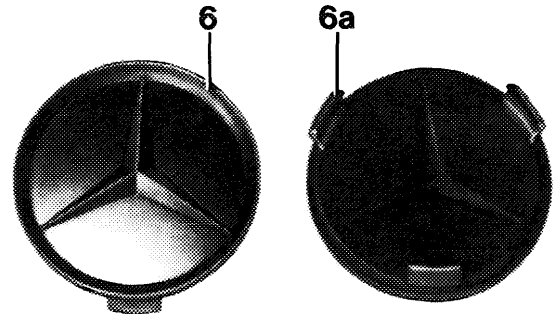

6 Plastic hub cap
6a Holding cam

140-23738

For removal, carefully push out hub cap from inner side of wheel, for insertion, push-on hub cap with ball of thumb.

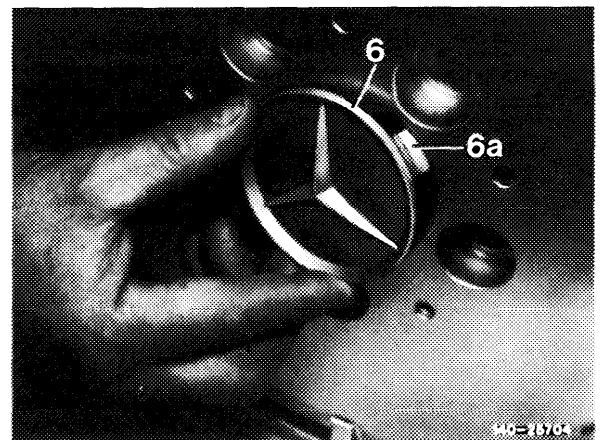

6 Plastic hub cap
6a Holding cam

140-21704